

CONTAMINATION MONITORING PRODUCTS

**INSTALLATION,
SERVICE AND
MAINTENANCE MANUAL**

CML3
**COMPACT PORTABLE
CONTAMINATION
MONITOR**



EN

PASSION  PERFORM





PRODUCT OVERVIEW

CML3 - Compact Portable Contamination Monitor

A compact and portable particle counter that delivers a fast, accurate assessment of contamination in the field and is the perfect solution for the mobile, construction and plant hire sectors.

Easy to master, the new CML3 has been specially designed to open up the latest in contamination control technology to everyone from fleet service engineers to specialist technicians seeking an advanced hydraulic health check on critical systems.

The CML3 is easy to master with intuitive software - making real-time assessments as well as predictive maintenance and long-term trend monitoring easier than ever before.

Features and Benefits

- High-resolution 7" (178 mm) touchscreen display
- Real-time contamination results at-a-glance
- High-speed sample times
- Pressurised sampling up to 420 bar
- Work-all-day battery
- Portable at just 7.7 kg (17 lbs) - with accessories: 10 kg (22 lbs)
- Easy to master - operators can get up and running in minutes
- Enables proactive maintenance
- Measures and displays the following international standard formats: ISO 4406, NAS 1638, AS 4059E&G Tables 1 and 2, ISO 11218, GBT 14039, GJB 420B, GOST 17216, ISO 11218
- Optional moisture / temperature sensors
- Data logging and 4000 test result memory
- CMP View software (included on Data stick)
- Full accessories kit included



Product Presentation

The CML3 measures and quantifies the solid contaminants in hydraulic applications. The unit is designed to be an accurate instrument for applications using mineral oil as the operating fluid.

The unit can operate using any of the international standard formats ISO 4406, NAS 1638, AS 4059E&G Tables 1 and 2, ISO 11218, GBT 14039, GJB 420B, GOST 17216

The CML3 incorporates a connector for power as well as separate USB connections for connection to a personal computer for remote monitoring; settings access; and direct download to a USB memory stick.

The integrated data logger records up to 4000 test results internally, for use where a computer cannot be permanently connected.

The instrument utilises the light extinction principle whereby a specially collimated precision LED light source is used to illuminate the test media. This light is then captured via a photodiode module. When a particle passes through the beam it reduces the amount of light received by the diode, and from this change in condition, the size of the particle can be deduced and subsequently counted.

Product features

Optional moisture sensor

The CML3 measures water content using a capacitive RH (relative humidity) sensor. The result is expressed as percentage of saturation. 100% RH corresponds to the point at which free water exists in the fluid, i.e. the fluid is no longer able to hold the water in a dissolved solution. This is also normally the point at which significant damage occurs in a hydraulic system, making RH% an ideal measurement scale that is independent of the fluid characteristics.

The water saturation point (100% RH) is temperature dependent, so the temperature is measured at the same time. This enables results to be compared meaningfully.

The temperature measured is that of the fluid passing through the unit.

Note: This may differ from that of the hydraulic system, depending on flow rate, pipe length and ambient temperature. It is not intended to be an accurate indication of system temperature, but to provide a reference for the RH measurement at the point of sample. Nevertheless, experience has shown the temperature measured is within a few degrees of that of the hydraulic system, in most applications.

PRODUCT OVERVIEW

Data logger

The CML3 includes a built-in data logger, which adds the facility to log and timestamp test results in the internal memory, even when not connected to a computer

- Each log entry is time-stamped and contains the CML3 serial number, so that it can be identified later
- The CML3 memory has space for around 4000 log entries. When full, the oldest log entry is overwritten

Data transfer via USB stick

All versions of the CML3 allow direct download to a USB data stick. With the CML3 powered ON, plug the USB data stick into the USB connector on the side of the unit.

The USB data stick icon appears on the right-hand side of the screen when the data stick is plugged in. The arrow icon pointing to the icon is visible when the CML3 tries to write the log file to the data stick. A successful download is denoted by a green tick emblem. If the download fails, a red cross icon will appear. If this error is present, the data stick may need to be re-formatted (formatting should be done to FAT32).

The icon will remain visible until the USB data stick is removed, at which point all the icons associated with the USB download function disappear.

The USB data stick provided with the unit is pre-formatted for the transfer. Other USB data sticks may need to be re-formatted (FAT32 or FAT32Ex filesystems, this is normal for file transfers between Windows systems and devices).

Fluid compatibility product versions

M version: Mineral oils and synthetic fluids.



DECLARATION OF CONFORMITY

CE Declaration of Conformity

The products included in this Declaration are all variants of the following:

- With or without moisture sensor
- Compatible with mineral oil/ synthetic fluids
- With USB download
- With touchscreen display

For part codes see the ordering codes on page 31.

Product Manufacturer:

MP Filtri UK
Keep House
Conference Way
Vale Park South
Evesham
Worcestershire
WR11 1LB
01386 258500
sales@mpfiltri.co.uk

The products described are in conformity with the following directives:

2014/30/EU Electromagnetic Conformity

Certification Testing that has been carried out is in accordance with:

- DEF STAN 00-35 Part 3 issue 4 Environmental Test Methods
- BS EN 60068 range of standards covering environmental conditions
- BS EN 60529: 1992 + A2:2013 Degrees of Protection provided by enclosures (IP Code)
- BS EN 62262:2002 Degrees of Protection Provided for Electrical Equipment against External Mechanical Impacts (IK Code)
- BS EN 60721-3-4: 1995 Part 3: Classification of Groups of Environmental Parameters and their severities, Section 3.4

Date: Sept 2024

Signed:

Kris Perks (Engineering Director) on behalf of MP Filtri UK Ltd



	Page
PRODUCT OVERVIEW	
Product Presentation	2
EC Declarations of Conformity	4
Table of Contents	6
GENERAL WARNINGS	
1 General warnings and information for the recipient	8
1.1 General safety warnings	8
1.2 Dangers and Hazards that cannot be eliminated	10
1.3 Personal Protective Equipment	10
1.4 Precautions related to product handling of the Liquid Crystal Touchscreen display	10
TRANSPORT AND STORAGE	
2 Transportation and Storage	10
2.1 Transportation and Handling Conditions	10
2.2 Storage	10
GENERAL WARRANTY CONDITIONS	
3 Warranty, limits and exclusions	11
3.1 Warranty on Recalibration	12
3.2 Download Area	13
PRODUCT DOCUMENTATION	
4 Technical specification	14
4.1 Performance	14
4.2 Electrical Interface	14
4.3 Physical Attributes	15
4.4 Fluid Characteristics	15
4.5 Environment	15
4.6 Wetted parts	15
4.7 Dimensions	16
4.8 Designation & Ordering code	16
TECHNICAL SPECIFICATION	
5 Product Installation and General Operation	18
5.1 Installation	18
5.1.1 Physical procedure	18
5.1.2 Electrical interface	18
5.2 General operation	19
5.2.1 Physical checks	19
5.2.2 Front panel operation and calibration due date	19
5.2.3 Home screen	19
5.2.4 Test reference	20
5.2.5 Test format	20
5.2.6 Last test result	20
5.2.7 Detailed results viewer	20
5.2.8 Settings	20
5.2.9 Printer	21

TABLE OF CONTENTS

5.2.10	Battery status change	21
5.2.11.1	Sampling timer	21
5.2.11.2	Continuous test	21
5.2.12	Test type toggle mode	21
5.2.13	Test start/stop operation	22
5.2.14	Manual flush operation	22
5.2.14.1	Normal test	22
5.2.14.2	Continuous test	22
5.2.15	Temperature result	22
5.2.16	RH result	22
5.3	Settings menu	23
5.3.1	Water Content	24
5.3.2	Time Settings	24
5.3.3	Diagnostics	24
5.3.4	Contamination Tolerance Limits	24
5.3.5	Historical results and trend monitoring	27
5.3.6	Wifi	27
5.3.7	Home Icon	27
5.3.8	Erase Logs	28
5.3.9	Printer Settings	28
5.3.10	Simulation	28
5.3.11	Language	28
5.3.12	Brightness Slider	29
5.4	Online Mode	29
5.5	CML3 removal and product maintenance	30
5.6	Disposal	30
6	Spare Parts	31
6.1	Spare parts list	31
6.2	Accessories	31
7	Troubleshooting / FAQ	32
7.1	Misuse of product	32
7.2	Fault Finding	32

1 General warnings and information for the operator

1.1 General safety warnings

Do not operate, maintain or carry out any procedure before reading this manual. Any individual operating the unit shall wear the following Personal Protective Equipment:

- Protective eyewear
- Safety shoes
- Gloves
- Overalls (or other suitable protective clothing)

Before carrying out any machine installation procedures and/or before use, one should scrupulously follow the instructions listed in this manual. Moreover, it is necessary to comply with the current regulations related to occupational accident prevention and safety in the workplace.

Notices aimed at the prevention of health hazards for personnel operating the machine are highlighted in this document with signs having the following meaning:

It relates to important information concerning the product, its use or part of this documentation to which special attention must be paid



NOTE

It means that failure to comply with the relevant safety regulations may result in mild injury or property damage.



CAUTION

It means that failure to comply with the relevant safety regulations may result in death, serious injury or serious property damage.



DANGER

Failure to comply with the relevant safety regulations may result in death, serious injury or serious property damage.

GENERAL WARNINGS

To allow rapid identification of the employees who must read this manual, definitions have been used with the following meaning:

OPERATOR	This is any individual whose task is to use the machine for production purposes. The operator is aware of all the measures taken by the machine manufacturer in order to eliminate any source of injury risk in the workplace and takes into account the operational constraints.
PERSONNEL INVOLVED IN SLINGING AND HOISTING OPERATIONS	This is any individual whose task is to handle the machine or parts of it. Personnel involved in slinging and hoisting operations are aware of the issues regarding the safe transfer of machinery or parts of it and, therefore, uses appropriate lifting equipment, following the instructions provided by the product manufacturer.
MACHINE SETTER	This is any individual whose task is to set up the machine for its operation. The machine setter is aware of the measures taken to eliminate all sources of injury risks in the workplace and takes into account the operational constraints. The machine setter takes all the appropriate precautions in order to operate in utmost safety conditions.
MAINTENANCE TECHNICIAN	This is any individual whose task is to carry out maintenance activities on the machine. The maintenance technician is aware of the possible danger situations that may arise and takes the appropriate precautions in order to eliminate the risks of accidents in the workplace.
ELECTRICIAN	This is any individual whose task is to carry out maintenance activities on the electrical wiring of the machine. The electrician is aware of the possible danger situations that may arise and takes the appropriate precautions in order to eliminate the risks of accidents in the workplace.

The unit shall be taken out of service and/or dismantled in accordance with the current regulations in force in the country where the machinery is installed









1.2 Dangers and hazards that cannot be eliminated

- Risk of hydraulic injection injury
- Burn risk because of high temperatures
- Accidental oil leaks with consequent risk of slipping
- Hose breakage and resulting lubricant loss
- With oil temperatures exceeding 40/45 °C (100/115 °F), it is vital to be extremely careful when handling the unit. Avoid direct contact with hot oil.

AFTER USE - ALL EQUIPMENT SHOULD BE ALLOWED TO COOL PRIOR TO HANDLING

1.3 Personal protective equipment

When operating the unit, personnel must be wearing safety shoes, gloves and goggles/safety glasses. In general, the PPEs to be used according to the activities on the machinery are listed in the following table:

ACTIVITY	PPE
Ordinary operation	Shoes, gloves, goggles, overall   
Planned maintenance	Shoes, gloves, goggles, overall   

1.4 Precautions related to product handling of the Liquid Crystal Touchscreen display

- If the LCD panel breaks, be careful not to get the liquid crystal to touch your skin.
- If the liquid crystal touches your skin or clothes, please wash it off immediately by using soap and water
- Avoid any strong mechanical shock which can break the glass.

2 Transportation and Storage

2.1 Transportation and handling conditions

The unit is shipped in a cardboard box with appropriate protective packaging and these should be recycled accordingly where possible. The packed weight of the CML3 and accessories is 11 kg (24 lbs)

2.2 Storage

The unit should be stored in a suitable location away from the production area when not in use. The unit should be stored with the caps provided on the ports. This location should not impede any other production or personnel.

WARRANTY

3 Warranty, Limitations and Disclaimers

MP Filtri warrants that the products that it manufactures and sells will be free from defects in material, workmanship & performance for a period of 12 months from the date of shipment.

Hardware/Firmware

Should the hardware prove defective during the warranty period, MP Filtri, at its discretion, will either repair the defective product or replace it with an equivalent product in exchange for the defective unit without charge for parts, labour, carriage and insurance.

Software

MP Filtri warrants that software will operate substantially in accordance with its functional specification for 12 months from date of shipment provided that the integrity of the operating environment has not been compromised through misuse, inappropriate handling, abnormal operating conditions, neglect or damage (unintentional or otherwise) or the introduction of third party product (software or hardware) that in any way conflicts with the MP Filtri product.

Eligibility

This warranty extends to the original purchaser only or to the end-user client of a MP Filtri authorised affiliate.

How to obtain service?

To obtain service under the terms of this warranty, the customer is required to notify MP Filtri before the expiration of the warranty period and to return the item in accordance with MP Filtri product return policy. Any product returned for warranty repair must be accompanied by a full fault report specifying the symptoms and the conditions under which the fault occurs. Should MP Filtri incur additional cost as a result of a failure to complete the appropriate paperwork, an administrative charge may be levied.

Exclusions

This warranty shall not apply to any defect, failure or damage caused by improper use or improper or inadequate care. MP Filtri shall not be obligated to provide service under this warranty if:

- a) Damage has been caused by a failure to make a full and proper inspection of the product (as described by the documentation enclosed with the product at the time of shipment) on initial receipt of the product following shipment;
- b) Damage has been caused by the attempts of individuals, other than MP Filtri staff to repair or service the product;
- c) Damage has been caused by the improper use or a connection with incompatible equipment or product including software applications.

Charges

Under cover of this warranty, MP Filtri will pay the carriage and insurance charges for the shipment of defective product back to site of manufacture and for its return to the client's original site of despatch except when:

- a) MP Filtri product return policy has not been followed.
- b) Product failure is caused by any of the exclusions described above, when the customer will be liable for the full cost of the repair (parts and labour) plus all carriage and insurance costs to and from MP Filtri premises.
- c) The product is damaged in transit and a contributory cause is inadequate packaging. It is the customer's responsibility to ensure that the packaging used to return equipment to MP Filtri is the same, or has equivalent protective qualities, to that used to ship the product to the customer in the first instance. Any damage resulting from the use of inadequate packaging will nullify MP Filtri

obligations under this warranty. Should the customer's product be damaged in transit following a repair at MP Filtri site, a full photographic record of the damage must be obtained (packaging and the product) to support any claim for recompense. Failure to present this evidence may limit MP Filtri obligations under this warranty.

THIS WARRANTY IS GIVEN BY MP FILTRI IN LIEU OF ANY OTHER WARRANTIES, EXPRESS OR IMPLIED, INCLUDING BUT NOT LIMITED TO ANY IMPLIED WARRANTY OF MERCHANTABILITY, NON INFRINGEMENT OR FITNESS FOR A PARTICULAR PURPOSE. MP FILTRI LTD SHALL NOT BE LIABLE FOR ANY SPECIAL, INDIRECT, INCIDENTAL OR CONSEQUENTIAL DAMAGES OR LOSSES (INCLUDING LOSS OF DATA), WE SPECIFICALLY DISCLAIM ANY AND ALL WARRANTIES TO CUSTOMERS OF THE CUSTOMER. THE CUSTOMER'S SOLE REMEDY FOR ANY BREACH OF WARRANTY IS THE REPAIR OR REPLACEMENT, AT MP FILTRI DISCRETION, OF THE FAILED PRODUCT.

MP Filtri Ltd maintains a policy of product improvement and reserves the right to modify the specifications without prior notice.

3.1 Warranty on Recalibration

The CML3 is guaranteed for 12 months upon receipt of the product, subject to it being used for the purpose intended and operated in accordance with this User Guide.

MP Filtri will only verify the accuracy of the CML3 if the unit is recalibrated every 12 months.

Please ensure that the test results in the Log are downloaded to CMP View before the CML3 is despatched, in case action taken by MP Filtri during the service / recalibration causes the Log to be cleared.



NOTE

It is requested that only the CML3, not the support case or any other ancillaries, be returned for recalibration.

MP Filtri will not be held responsible for any items returned as such.

Ensure that the CML3 is packed appropriately for transportation.

PRODUCT DOCUMENTATION

3.2 Download Area

Please scan the QR codes below to get updated electronic version of the related document.

CONTAMINATION MONITORING PRODUCTS General catalogue



Download PDF

CMP View Software Quick Guide



Select your language and download PDF

CMP View Software Software multilingual

Download Software



4. Technical Specification

4.1 Performance

Technology	LED Based Light Extinction Automatic Optical Contamination Monitor
Particle Sizing	>4, 6, 14, 21, 25, 38, 50, 70 µm
Reporting Standards	ISO 4406; NAS 1638; AS4059 Rev E, Table 1; AS4059 Rev E, Table 2 AS4059 Rev G, Table 1; AS4059 Rev G, Table 2; GBT 14039 GJB 420 B; GOST 17216, ISO 11218
Calibration	Each unit individually calibrated with ISO Medium Test Dust (MTD) based on ISO 11171, on equipment certified by I.F.T.S. ISO 11943
Moisture & Temperature Measurement	% saturation (RH) and fluid temperature (°C / °F)
Accuracy	± 1 code

4.2 Electrical interface

Supply Voltage	18-19V
Supply Current	2.1-3.0A
Power Consumption	Charging state: ~40W max Idle state: 3W max Note: Power consumption level can vary dependant on fluid properties
Data Storage	Approximately 4000 time-stamped tests in the integral memory
Display	7" (178 mm) Capacitive touch-screen display with on board QWERTY keyboard 1024x600 pixels
Communication Options	USB, Wifi

TECHNICAL SPECIFICATION

4.3 Physical attributes

Dimensions	Width: 352 mm (13.8"). Height: 149 mm (5.8") - not including handle. Depth: 297 mm (11.7")
Weight	7.7 kg (17 lbs) - with accessories: 10 kg (22lbs)
Hydraulic Connections	Online mode: (High pressure) M16 x 2 (test point)

4.4 Fluid characteristics

Fluid compatibility	M: Mineral Oils, Synthetic fluids and diesel
Viscosity	≤ 400 cSt
Fluid temperature	Minimum: +5 °C (41 °F) Maximum: +80 °C (+176 °F)
Operating pressure	2 bar (29 PSI) - 420 bar (6091 PSI)

4.5 Environment

Ambient working temperature	Minimum: -10 °C (14 °F) Maximum: +60 °C (140 °F)
IP Rating	IP65 (Lid closed), IP54 (Lid open)

4.6 Wetted Parts

M version: Brass, Stainless Steel. Sapphire, NBR and FKM, PTFE, Nylon, FR4.

4.7 Dimensions

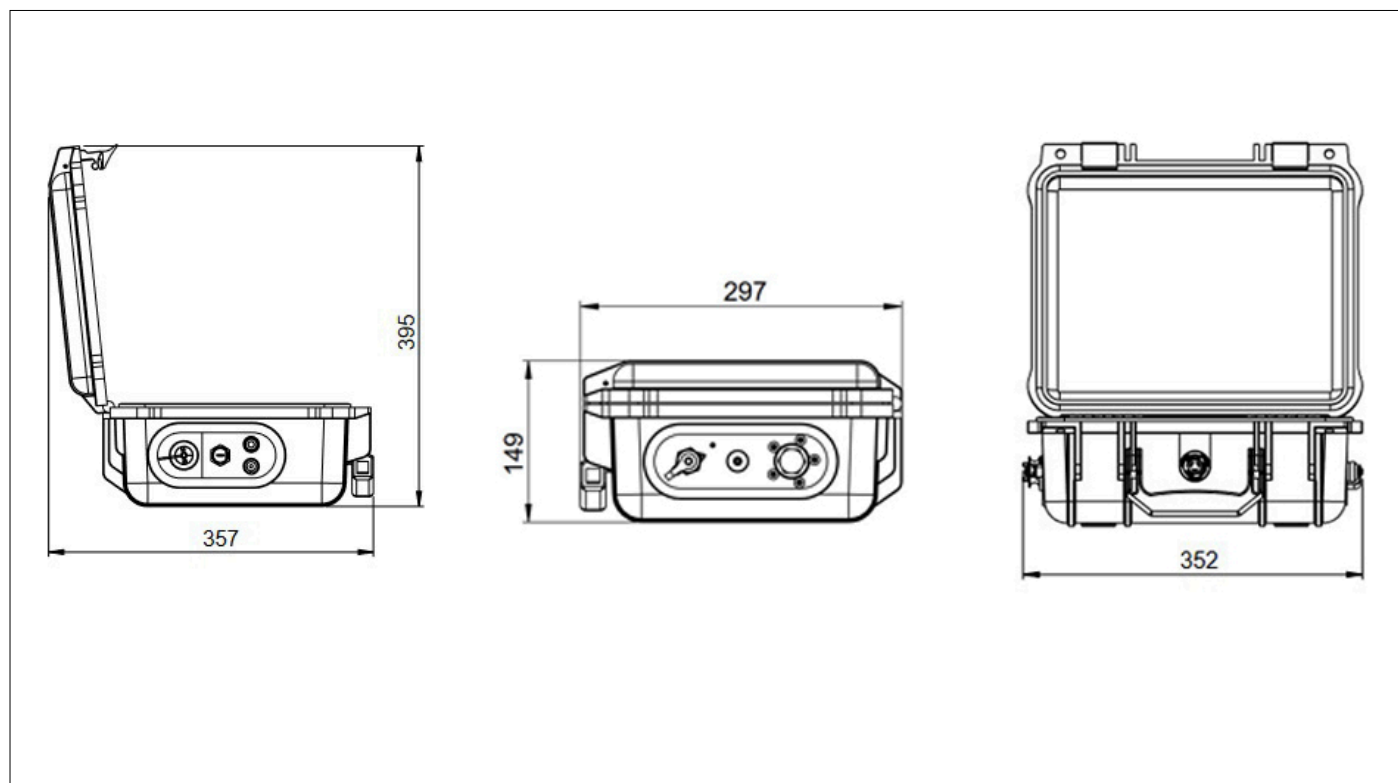

4.8 Designation & Ordering code

COMPACT PORTABLE CONTAMINATION MONITOR

Series	Configuration example: CML3 W 0 M 00 1					
CML3 Compact portable contamination monitor						
Sensor options: Moisture						
W With moisture and temperature sensor						
0 Without moisture and temperature sensor						
Sensor options: Pressure						
0 Without on-screen inlet pressure display						
Fluid Compatibility						
M Mineral oil and synthetic fluids						
Design Reference						
00 Standard option with full accessory kit and carry bag						
Country plug type						
1 UK						
2 US						
3 EU						
4 CN/AUS						

TECHNICAL SPECIFICATION

5. Product Installation and General Operation

5.1 Installation

Each CML3 supplied consists of the following:

- 1 x CML3
- 1 x M16x2 Microbore pressure hose, 1500 mm long + pouch
- 1 x 2000 mm Quick release waste hose + pouch
- 1 x Power cable and regional adaptors (UK/EU/US/CN/AUS)
- 1 x USB Stick with digital copies of product user guides, CMP View software, accessory products, drivers and product brochures
- 2 x Hard copy certificate of calibration
- 1 x Carry bag
- 1x 1500 mm quick-release offline hose and pouch (Low pressure)
- 1x USB C to USB A cable

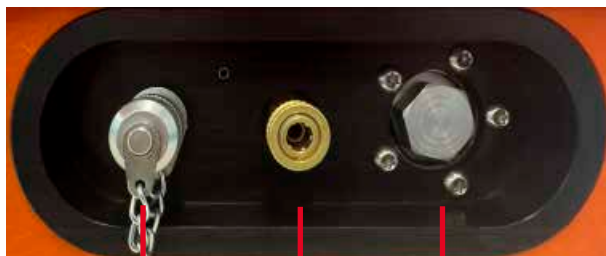

High pressure M16 x2
test point

Waste Outlet
quick-release coupling

Flow Control valve

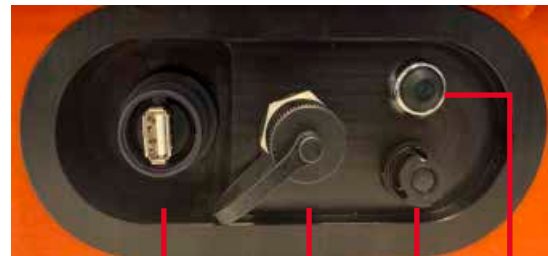

Power switch

DC charging port

USB C Connection port

USB data stick
download port

5.1.1 Physical procedure

Identify appropriate safe sample points and waste disposal routes.

Do NOT connect the system at this point. See section 5.4 for a detailed walkthrough.



CAUTION

Do NOT connect the waste hose to a pressurized system. This will cause the CML3 to malfunction and could cause internal damage. There must be no extra restriction placed on the waste hose, this must be vented to atmosphere.



NOTE

5.1.2 Electrical interface

The power on/off button is located at the side of the unit, see Section 5.1 (Page 17).

Pressing this will cause the CML3 to switch ON and startup screen will show on the display, see Figure 5.2 (page 19).

The charging port for the internal lithium ion battery is located directly below the power switch.

To engage the power connector, you must align the white arrow on the cable connector with the white line at the top of the chassis plug on the device itself.

Engage this fully and then rotate approximately 60° clockwise.

Reverse this action to remove the power charge cable.

The CML3 is designed as a standalone portable unit. However, if you wish to connect the product to a computer and use the product with CMP View software then this can be done via a USB A to USB C cable (this is provided with the unit).

The cable is plugged in to the USB connector (See section 5.1). The other end of the cable can then be connected to a PC that has MP Filtri's bespoke CMP View software loaded for communication/log download/remote control.

For further information on using the
CMP View software, please refer to Quick Guide:



There is also an option to expedite the log download direct to a USB data stick. An FAT32 formatted memory stick can be plugged to the 'A type' connector located on the side of the unit, to the left of the PC connection.

To ensure IP rating of the product is always met, caps for the USB connection MUST be reconnected after use



NOTE



It is imperative that upon the receipt of your product, the battery is fully charged before use. Ensure the unit be used to the point of depletion and then fully recharged again.

This will aid the life of the battery and allow the on board diagnostic circuit to be activated.



NOTE

PRODUCT INSTALLATION

5.2 General operation

5.2.1 Physical checks

- Oil leaks on and around the unit
- Fatigue in hoses and pipework that might then leak when under system pressure

5.2.2 Front panel operation and calibration due date

When the unit is first turned ON, the flash screen shown in figure 5.1 (below) will appear. The due date for recalibration of the product is stated in the center of the screen. This can also be found in the settings page of the unit. To progress to the main user screen, select the arrow in the bottom right corner of the screen.

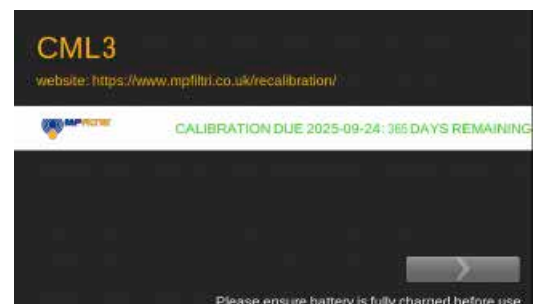
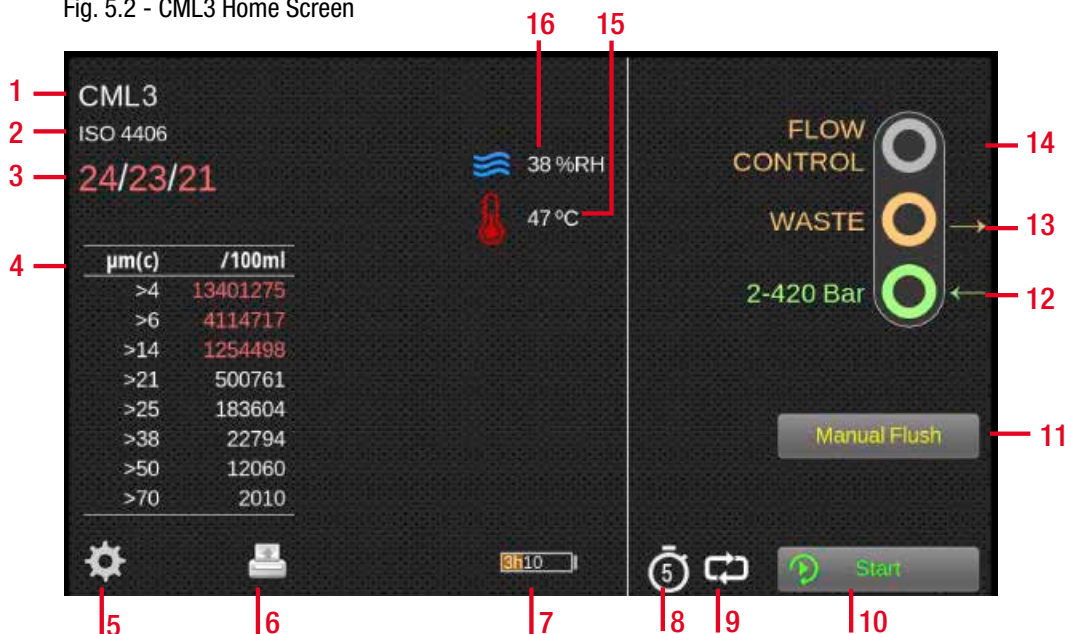

Fig. 5.1 - CML3 Flash Screen

5.2.3 Home screen

Note: upon initial start-up, the home screen will be blank until tests have been completed. Once test results are present in the product memory, the home screen will be laid out in the following manner.

Fig. 5.2 - CML3 Home Screen



Items:

- | | | |
|----------------------------|-----------------------------------|------------------------|
| 1. Test reference | 7. Battery charge status | 13. Outlet port |
| 2. Test format | 8. Test time selection button | 14. Flow control valve |
| 3. Last test result | 9. Continuous/single test mode | 15. Temperature result |
| 4. Detailed results viewer | 10. Test start/stop button | 16. RH result |
| 5. Settings | 11. Manual flush operation button | |
| 6. Printer | 12. Inlet port | |

5.2.4 Test reference

Home screen - Item 1

Programming of the test reference can be done by pressing the test reference icon. Here you can change the test reference as required, up to 31 characters. (Fig 5.3)

To confirm any changes, you must select "OK" with the green tick icon. To ignore any changes made; either select "CANCEL" via the red X icon, alternatively, the home screen icon in the bottom left corner can also be used (Home screen - Item 16, figure 5.2).



Fig. 5.3 - Test Reference Screen

5.2.5 Test format

Home screen - Item 2

Selecting the test format icon will open a new screen, (fig. 5.4), where the result format can be changed.

When changing the format, the desired format must be selected and then the tick icon in the bottom right corner pressed to confirm.

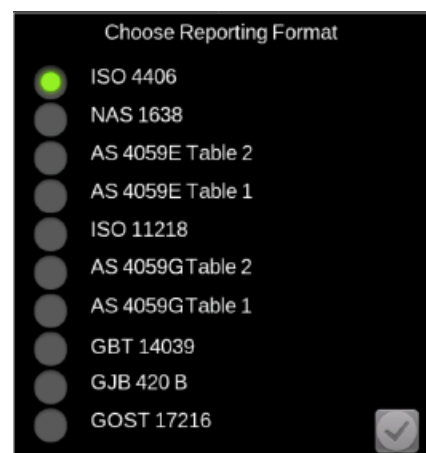

Fig. 5.4
Reporting
Format Screen

5.2.6 Last test result

Home screen - Item 3

This is where the last test result is shown.

If no tests have been carried out since the unit has been turned on, then -/-/- will be displayed.



Fig. 5.5
Detailed Results

5.2.7 Detailed results viewer

Home screen - Item 4

This area shows the detailed counts information for the last test result (Fig 5.5).

5.2.8 Settings

Home screen - Item 5

Selecting the Settings Icon (Fig 5.6) will open the options screen.

The sub-menu of the options screen can be viewed at section 5.3



Fig. 5.6

PRODUCT OPERATION

5.2.9 Printer

Home screen - Item 6

Tapping the printer icon (Fig 5.7) will print the last test result in the result format currently displayed on the screen. The printer operates via Bluetooth and is an optional extra.



Fig. 5.7

5.2.10 Battery status charge

Home screen - Item 7

The charge percentage level (Fig 5.8) is shown here in the top right corner of the home screen. The colour of the battery matches that of the LED:



Fig. 5.8

Green - More than 70% level of charge remaining

Yellow - Between 20-70% charge

Red - Below 20% charge

The graphic also shows an estimated time associated with the charge remaining in the battery.

5.2.11.1 Sampling timer

Sampling timer - Item 8

Sample times are selected by pressing the related icon (Fig 5.9.1).

Factory standard time is 2 minutes. Pressing the button will allow the operator to select between 2, 5 and 10 minute test times.



Fig. 5.9.1

5.2.11.2 Continuous test

Home screen - Item 9

A continuous test is allowed in online mode only by pressing the related icon (Fig 5.9.2)



Fig. 5.9.2

5.2.12 Test type toggle mode

Press on the continuous / single test Mode Icon to choose your preferred test type. (Fig 5.12).



Fig. 5.11



Fig. 5.12

5.2.13 Test start/stop operation

Home screen - Item 10

Selecting this icon will start and a sample/test. (Fig 5.13)

During a test the icon will 'fill' to show how much of the sample volume has been performed.



Fig. 5.13

5.2.14 Manual flush operation

Home screen - Item 11

Selecting this icon will allow a free flow of fluid through the unit.

This allows for any previously tested fluids to be purged from the hoses and the unit itself, thus reducing the risk of cross contamination as well as providing relevant fluid that is more indicative of what is occurring within the system at the time of test.



Fig. 5.14

It is recommended, when using the unit from a fully contaminated hydraulic system to a fully clean hydraulic system to run a manual flush for around 8-10 minutes.

Failure to flush/purge fluid from the unit and hoses will result in anomalous results and can affect the cleanliness reading achieved during the test.



5.2.14.1 Normal test

Pressing the start button will operate the test procedure.

5.2.14.2 Continuous test

To access the continuous test mode press on the related icon (Fig 5.17/5.18)

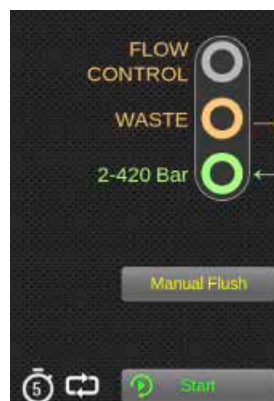

Fig. 5.16

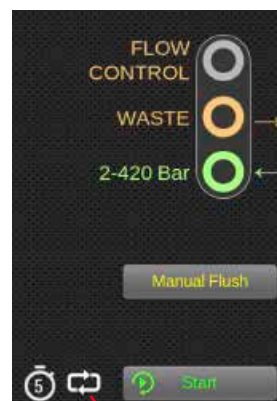

Fig. 5.17



Fig. 5.18

5.2.15 Temperature result

Home screen - Item 15. The last temperature result taken will be displayed here (Fig 5.19). The temperature / water sensor can be enabled/ disabled in the settings screen as detailed in section 5.3.1.

Pressing the temperature result, will alternate the reading between degrees Centigrade and Fahrenheit.



Fig. 5.19

5.2.16 RH result

Home screen - Item 16. The last RH test result will be displayed here (Fig 5.20).



Fig. 5.20

PRODUCT OPERATION

5.3 Settings menu

Home Screen - Item 5. Selecting this icon (Fig 5.21) will bring up the settings screen (Fig 5.22). This will allow you to modify settings in further detail.



Fig. 5.21

Fig. 5.22 - Settings screen

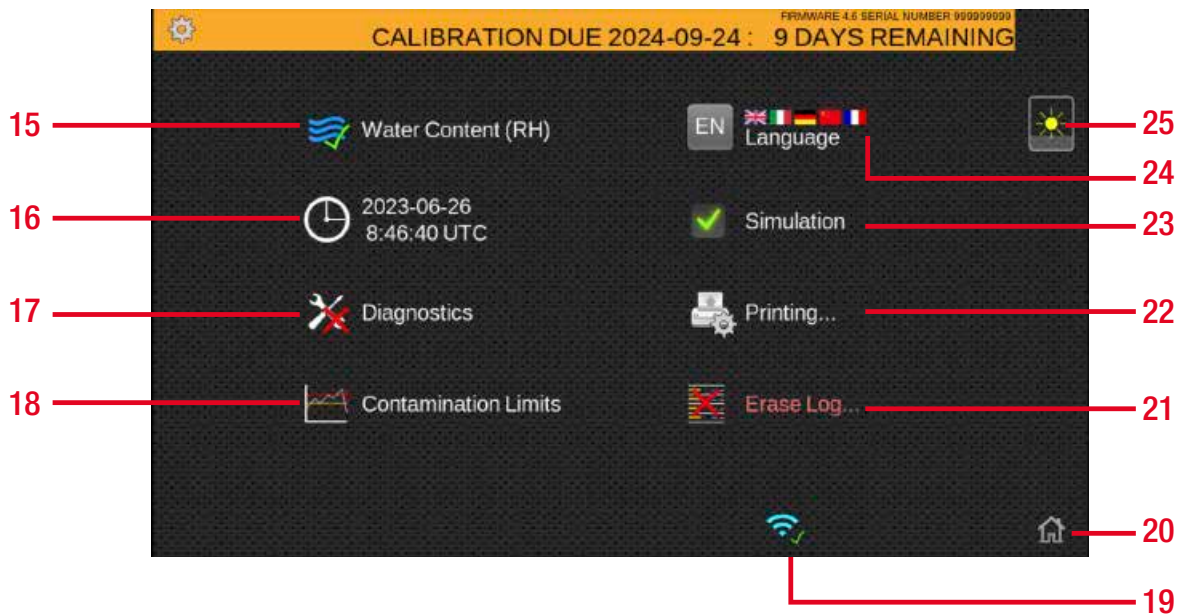

Items:

- | | | | |
|-----|--------------------------------|-----|--------------------|
| 15. | RH test enabled | 21. | Erase log |
| 16. | Time settings | 22. | Printer settings |
| 17. | Diagnostics | 23. | Simulation enabled |
| 18. | Contamination tolerance limits | 24. | Language |
| 19. | Wifi enabled | 25. | Brightness |
| 20. | Home | | |

5.3.1 Water content (%RH)

Settings Menu - Item 15

Tapping this icon will either enable or disable the RH sensor.

This will remain the same until it is selected again and will not default back when the unit is turned off.

If the icon has a green tick (Fig 5.23), then the RH option is enabled and if a red X is showing then the RH option is disabled and will not show on the test result.

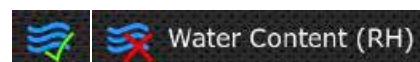

Fig. 5.23

5.3.2 Time settings

Settings Menu - Item 16

Pressing this icon allows the date and time to be set.

It is important to always set the Timezone first (Fig 5.24).

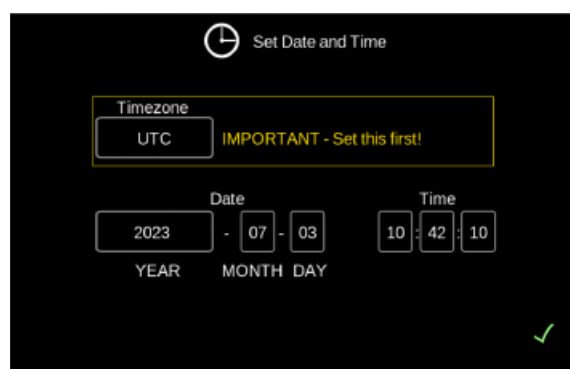

Fig. 5.24

5.3.3 Diagnostics

Settings Menu - Item 17

This icon is to view the diagnostics screen (Fig 5.25).

This is not accessible by end user and is only for MP Filtri personnel during calibration / repair.



Fig. 5.25

5.3.4 Contamination tolerance limits

Settings Menu - Item 18

This icon allows access to setting of the alarm levels associated with the selected reporting format.

Alarms can be set on combinations of cleanliness codes, water content and temperature. The available codes, and their interpretation, vary according to the set test format. For example, it is possible to set a threshold of "NAS 11" or "ISO 18/16/15" or "AS4059E 8B-F", etc.

In general, there are upper and lower limits that can be set for the cleanliness level, also for water content and temperature if applicable. An alarm, if enabled, will become active if any of the associated (upper/lower) limits are exceeded. However, if a field is left empty (blank) this is interpreted as a "don't care" setting.

Alarms are colour coded: The result is coloured:

- Green if not greater than the lower limit, or else it is
- Yellow if not greater than the upper limit, or else it is
- Red

The "CML3" table is a dark interface showing ISO 4406 cleanliness levels. The title "CML3" and "ISO 4406" are at the top. Below is a date "24/23/21" in red. A table lists cleanliness levels in µm(c) and /100ml, with values in red.

µm(c)	/100ml
>4	13401275
>6	4114717
>14	1254498
>21	500761
>25	183604
>38	22794
>50	12060
>70	2010

Fig. 5.26

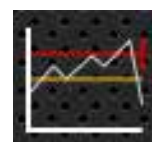

Fig. 5.27

PRODUCT OPERATION

ISO 4406 / GBT 14039 alarm levels

ISO4406 represents cleanliness using codes for the number of particles greater than 4, 6 and 14 μm . These codes can be used as limits for the alarms by selecting the ISO 4406 test format and then entering values as required (fig. 5.28).

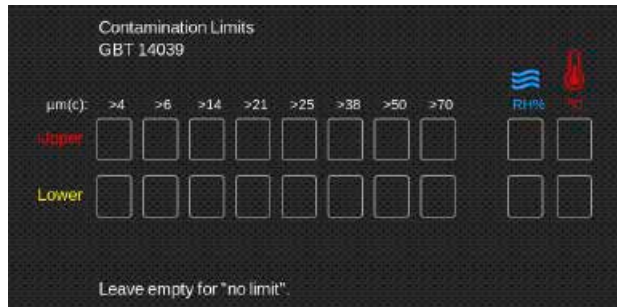
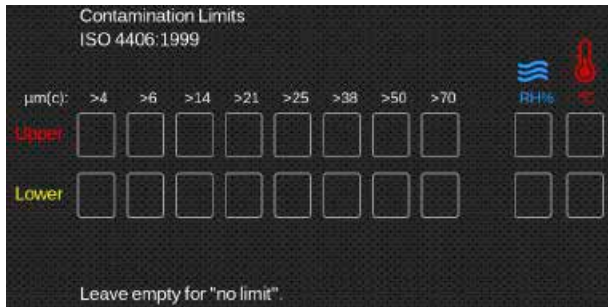
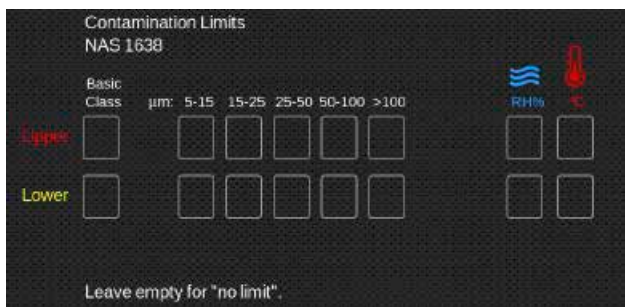

Fig. 5.28



NAS1638 alarm levels

NAS1638 can be used by selecting this as the test format. The headings and boxes for the available settings change appropriately. NAS1638 represents the overall cleanliness level as a single code, this being the highest of the individual codes generated for each defined particle size. Hence, we have the option of setting a limit on this overall contamination class (the Basic Class), or we can set individual limits on any combination of the classes for the defined particle size ranges (fig. 5.29).

Fig. 5.29

AS4059E Table 2 / AS4059G Table 2 alarm levels

AS4059E Table 2 uses letters instead of numbers to indicate the particle size range, so the settings are labelled appropriately. The standard specifies ways to represent a cleanliness level using only a subset of the available particle sizes, for example B-F. The user can achieve this by only entering settings for the sizes desired, leaving the others empty. So, a limit of AS4059 7B-F could be represented simply by entering a value of 7 for B, C, D, E, F.

AS4059G Table 2 is identical except the letters have been replaced by the numerical particle size values (fig. 5.30).

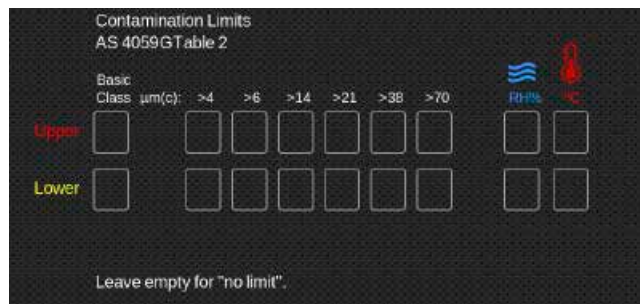
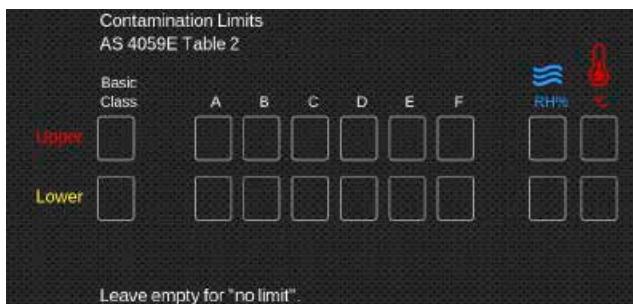

Fig. 5.30

AS4059E Table 1 / ISO 11218 / AS4059G Table 1 / GJB 420 B alarm levels

These four standards are similar except for terminology and reporting format. The actual numeric sizes and class thresholds are the same. Should an alarm exceed the programmed level, the corresponding format will show in the appropriate code/class (fig. 5.31)

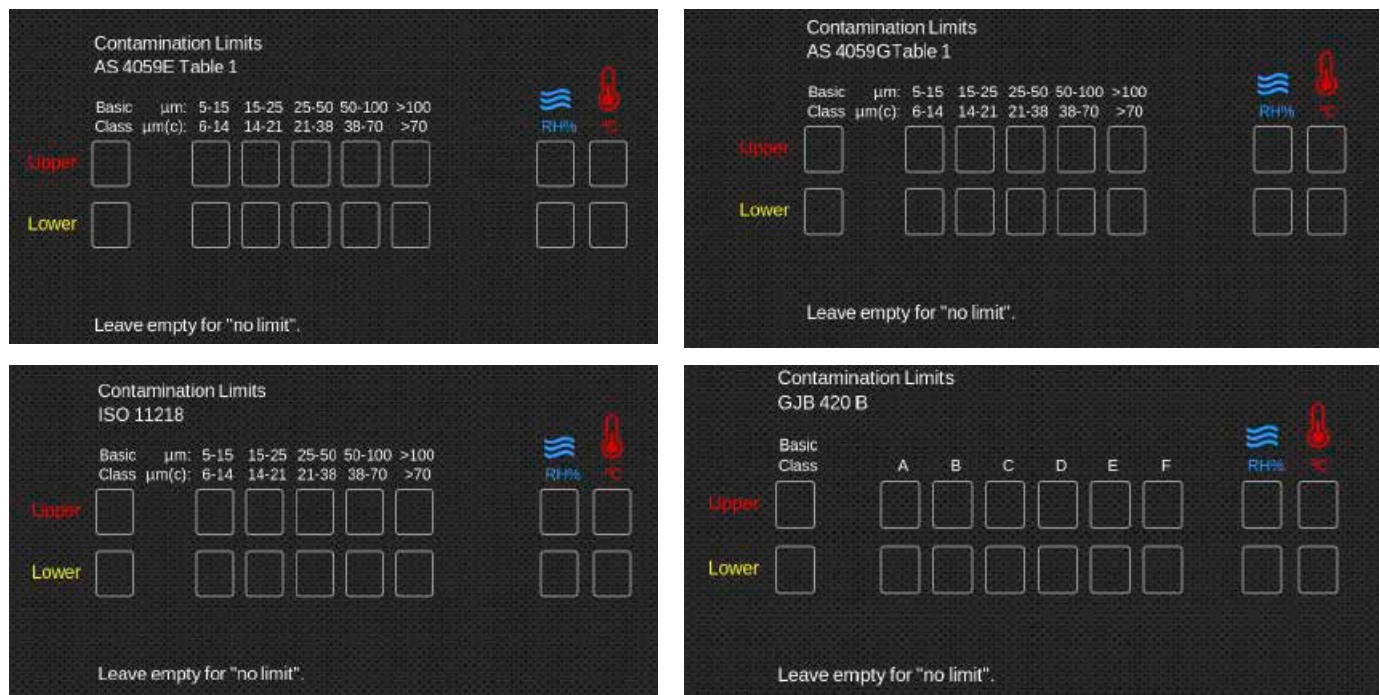

Figure 5.31

PRODUCT OPERATION

5.3.5 Historical results and trend monitoring

To gain access to historical data, connect your CML3 device to a PC or Mac via the USB C cable port. You can also connect via a USB data stick with results exported from your machine.

Download MP Filtri's CMP View software:



Once the CML3 is connected to the software you can view historical data and trend monitoring.

To connect to the software and master its functionality, see our training video at: <https://youtu.be/Exwv343EAfl>



CMP View - figure 5.32

5.3.6 Wifi

Settings Menus - Item 19

Click on the Wifi icon (Fig 5.33) to connect to your local wireless internet network. The IP address allocated to the network can be used to view live data when the CML3 is in operation.



Fig. 5.33

5.3.7 Home icon

Settings Menus - Item 20

This icon shows in all screens (Fig 5.34). Selecting this at any point will revert the unit to the home screen.



Fig. 5.34

5.3.8 Erase logs

Settings Menus - Item 21

Pressing the Erase Logs / Delete History icon will erase all records held within the CML3 memory.

Before proceeding with the deletion, the unit will ask for confirmation, (fig. 5.36)

It is important to ensure/verify that your log results have been downloaded and saved prior to deleting from the unit. Once the test history has been deleted from the unit, it cannot be reversed, all history will be lost.



Fig. 5.35

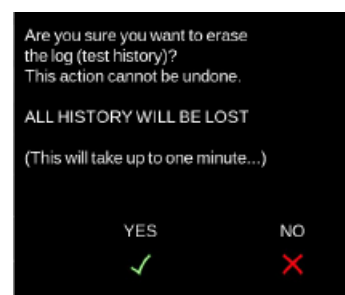

Fig. 5.36

5.3.9 Printer

Settings Menus - Item 22

This icon enables the user to modify the printer settings.

Selecting the icon will bring up a new screen where each option can be selected or deselected (fig. 5.37). These settings will save when the tick is pressed in the bottom right hand corner.



Fig. 5.37

5.3.10 Simulation

Settings Menus - Item 23

The simulation icon is mainly for demonstration purposes. If there is a tick present, then the simulation mode is enabled and when the test start icon is selected on the home screen the test process will run as a simulation on the screen.

No physical operation of the internal components will occur. Please note, this will stay enabled if the product is turned off.

Note: if the unit is accidentally left in Simulate mode, a warning will flag on the top right-hand side of the user screen



Fig. 5.38

5.3.11 Language

Settings Menus - Item 24

The CML3 is equipped with multiple languages, the default language is set to English (Fig 5.40). To alter to a preferred language, press the language icon, a selection window will open.

Select the language required, the window will close, and the language will automatically change to your selection.



Fig. 5.40

PRODUCT OPERATION

5.3.12 Brightness slider

Settings Menus - Item 25

Sliding your finger up and down the icon (Fig 5.41) will respectively increase and decrease the display brightness. Tapping the icon will change the brightness to the point where it is tapped.



Fig. 5.41

5.4 Online Mode

Step One: Connect the waste hose (Fig 5.42) to a waste receptacle (Fig 5.43) and then connect to the CML3 waste outlet quick-release attachment.

Step two: Connect the pressure hose to the CML3 high pressure inlet first. Then connect to the high pressure test point on the system. Please refer to the safety instructions in Section 1.1



Fig. 5.42

Fig. 5.43

Ensure only one inlet hose is connected when testing. Do not conduct tests with more than one inlet hose connected



Step three: The CML3 is now ready to take samples from pressurised systems.

The CML3 is now ready to take samples from pressurised systems. To begin sampling set the timer to 2, 5 or 10 minute test time by pressing on the Test time selection button.

To begin sampling switch to online mode on your device and press start. Press on the Continuous/Single test Mode Icon (fig 5.45) to choose your preferred test type.

Flow Control: The valve is designed to be removable to allow for any required cleaning operations.

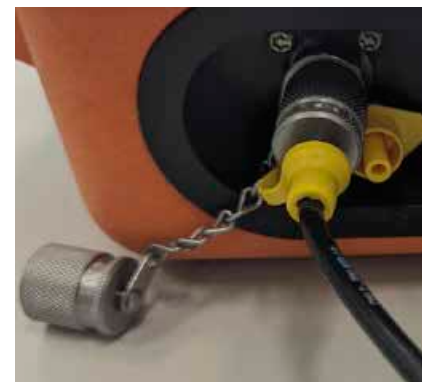

Fig. 5.44

Step Four: The results will appear on the main screen. You can also use the optional bluetooth printer to get a hard copy (Fig 5.46).



Fig. 5.45



Fig. 5.46

5.5 CML3 removal and product maintenance

When disconnecting the CML3 from the system ensure the system pressure is shut off from the CML3. Ensure hydraulic system is unpressurised.

- Press manual flush button to flush unit
- For online mode: Disconnect the high-pressure hydraulic hose from the M16x2 test point on the system.
For offline mode: Disconnect the related hose from container
- Disconnect the hose from the particle analyser High pressure (online) test point connector or Low pressure (offline) quick-release coupling.
- Allow any fluid to drain from the hose into the waste container.
- NOTE: Ensure any spillages are cleaned up and that all fluids are disposed of in accordance with local legislations
- Wipe away any residual oil from around the connectors in the CML3 bulkhead and then replace the caps

5.6 Disposal

All CML3 products are sent in a cardboard box with appropriate protective packaging and these should be recycled accordingly where possible.

Fluids used with the CML3 should be fully drained and disposed of according to EU waste framework directive and ISO 14001 Environmental Management.

PRODUCT OPERATION/SPARES

6 Spare Parts

6.1 Spare parts list

Description (Product types)	Ordering Code
Calibration Verification Fluid (requires use of Bottle Sampling device)	PCCF
M16x2 microbore pressure hose, plated steel, 600 mm (M versions)	95.Y30Y30X261060
M16x2 microbore pressure hose, plated steel, 1500 mm (M versions)	95.Y30Y30X261150
Waste Hose (M versions), 2000 mm - Brass/FKM	SK0014S30
Pouch for inlet pressure/offline hose and waste hose	7.106
M16x2 M to F Coarse Screen Filter (M and N versions)	SK0040
1 Litre - Square (for use with CB0001)	SK0013
1m USB A to C Cable	443.074000
USB stick with all user guides and CMP View Software	13.055001
19V, 3A Power Adapter	61.034000
UK Lead for Power Adapter	8.031
EU Lead for Power Adapter	8.032
US Lead for Power Adapter	8.030
CN/AUS Lead for Power Adapter	8.072
Thermal printer paper 57x33mm	63.083000
CML Carry Bag	10.011
Bluetooth Printer	482.016000

For further information please download the Contamination Control Solutions catalogue:



6.2 Accessories

Bluetooth Printer: MP Filtri item number: 482.016000

Wireless, Bluetooth 4.0, Direct heat printer with no expensive ink replacement require. Compact, quiet, high-speed printing.

Support for Android, for IOS and Windows



7 Troubleshooting / FAQ

7.1 Misuse of product

- The product should be connected to a power supply within the rating of the product and not wired directly to the mains
- This product should be connected to a hydraulic line; this must be within the pressure range of the unit: 2 to 420 bar (29 to 6091 PSI).
- Connection hoses should never be allowed to lie along the floor when the CML3 is installed and in use
- The operator should follow all standard operating procedures previously set at the operating location as well as the procedures required by the manufacturer
- The CML3 is not suitable for use in an explosive environment or an ATEX zone
- Over-tightening of test points/ hoses can damage threads causing the unit to fail

7.2 Fault finding

Unexpected results obtained from sample

- Check that the microbore pressure hose has been fully connected at both the system and CML3 ends.
- High water / aeration levels
- Antifoam additive package within sample fluid

Remote Device dialogue not responding to buttons being pressed

- Check that correct COM port has been selected in the Remote Device dialogue.
- Check USB driver has been installed.
- Disconnect power supply to CML3 and then reconnect it.

If the CML3 has been subjected to excessive contamination and a blockage is suspected, a flush with a suitable fluid (such as hydraulic mineral oil) may clear the blockage.

DO NOT USE ACETONE

All data, details and words contained in this publication are provided for use by technically qualified personnel at their discretion, without warranty of any kind.

MP Filtri reserves the right to make modifications to the models and versions of the described products at any time for both technical and/or commercial reasons.

For updated information please visit our website: www.mpfiltri.com

The colors and the pictures of the products are purely indicative.

Any reproduction, partial or total, of this document is strictly forbidden.

All rights are strictly reserved

WORLDWIDE NETWORK

CANADA ♦ CHINA ♦ FRANCE ♦ GERMANY ♦ INDIA ♦ SINGAPORE
UNITED ARAB EMIRATES ♦ UNITED KINGDOM ♦ USA



PASSION  PERFORM

in @ y f



mpfiltri.com
Scan or click me!